

TAP-100-10-12 -- High-Strength Anchor Helix

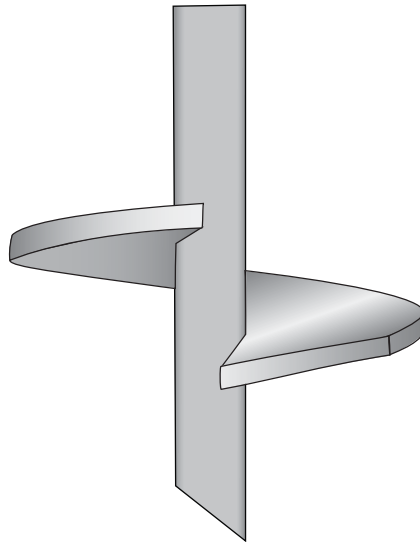

Product Specifications	
Anchor Style	Power Installed Torque Anchor
Number of Helices	1
Single Helix	12" (305 mm)
Rod Diameter	3/4"(19.1 mm) or 1" (25.4 mm)
Torque Rating	7,000 ft lbs (9,492 N-M)
Square Hub	1.5" (38.1 mm)
Coating	Painted (optional Hot-Dip Galvanized)
Standard Package	2 per Box 48 per PLT
Standard Package Unit	Each
Min Order Qty	1
Weight/Ea	18 lbs

Notes
 High-Strength Anchor Helix; 7,000 ft lbs (9,492 N-M), 12" (305 mm) Helix for use with 3/4"(19.1 mm) or 1" (25.4 mm) rod