

TAF-175-36-8-10 -- Square Shaft 1-3/4" RCS Lead Section

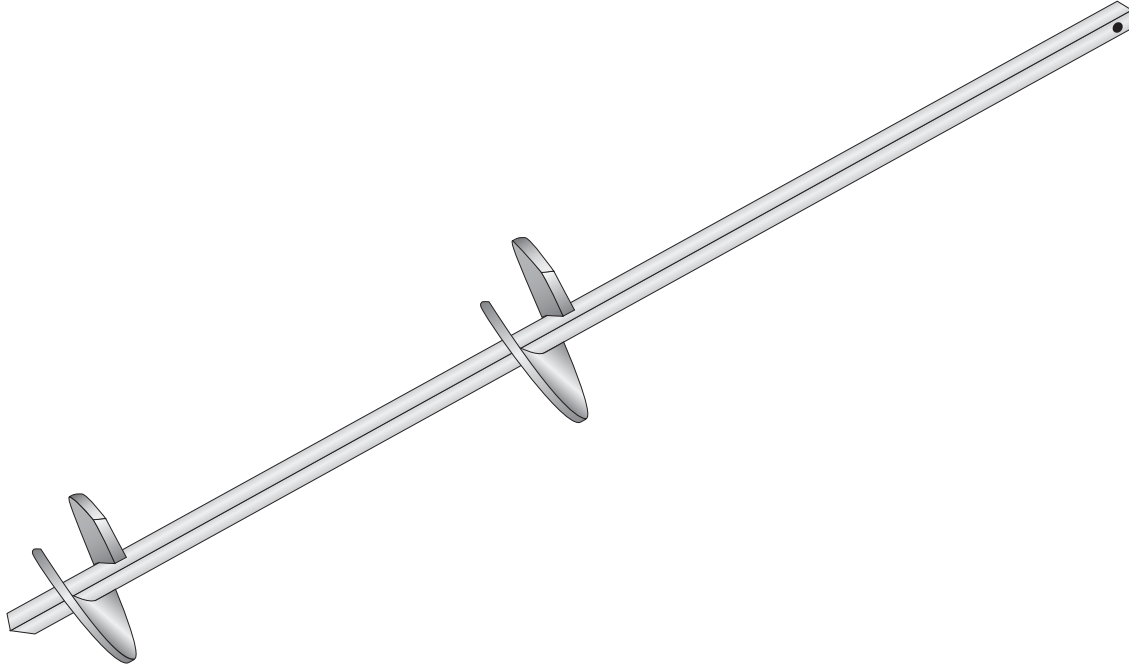

Product Specifications

Anchor Style	Square Shaft (175) Anchor
Component	Lead Section
Number of Helices	2
Helix Diameter	8" (203 mm) - 10" (254 mm)
Length	36" (914 mm)
Flight Thickness	3/8" (9.5 mm)
Flight Yield Strength	50,000 lbs (222.4 kN)
Rod Tensile Strength	100,000 lbs (444.8 kN)
Torque Rating	10,000 Ft Lbs (14,914 N-M)
Coating	Hot-Dip Galvanized
Standard Package	1
Standard Package Unit	EA
Min Order Qty	25
Weight/Ea.	43 lbs
Weight Per Pallet	1075 lbs

Notes

Square Shaft (175) Lead Section, 36" Length (914 mm) long with 8" (203 mm)-10" (254 mm) Helices