

TAF-150-84-10-12 -- Square Shaft 1-1/2" RCS Lead Section

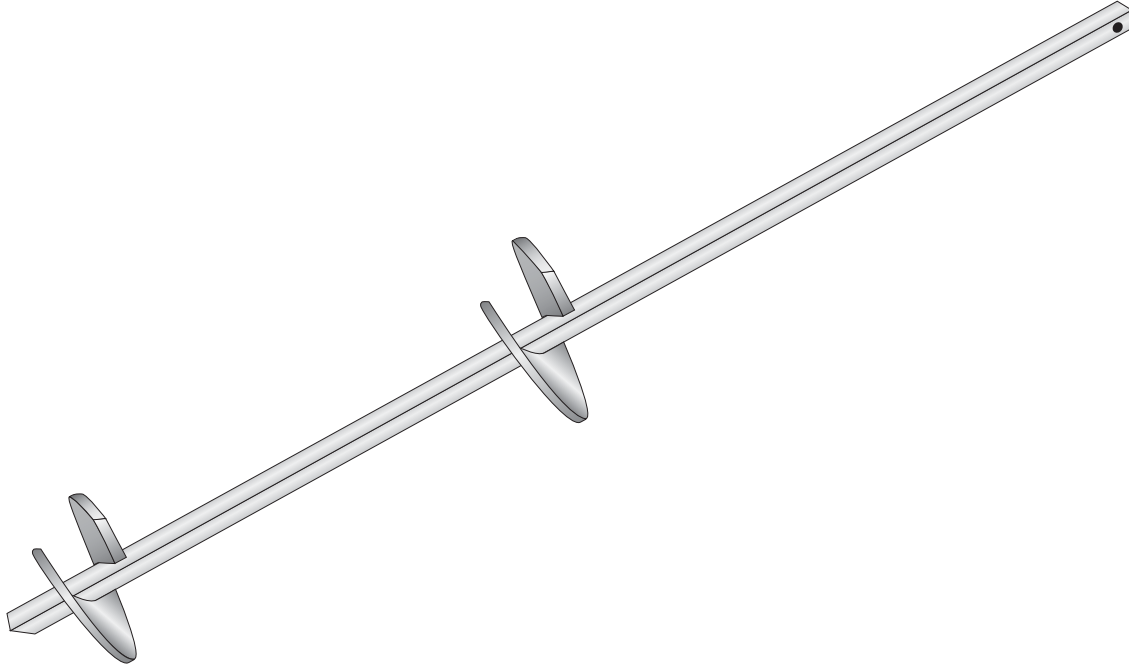

Product Specifications

Anchor Style	Square Shaft (150) Anchor
Component	Lead Section
Number of Helices	2
Helix Diameter	10" (254 mm) - 12" (305 mm)
Length	84" (2134 mm)
Flight Thickness	3/8" (9.5 mm)
Flight Yield Strength	50,000 lbs (222.4 kN)
Rod Tensile Strength	70,000 lbs (311.4 kN)
Torque Rating	7,000 Ft Lbs (9,492 N-M)
Coating	Hot-Dip Galvanized
Standard Package	25
Standard Package Unit	EA
Min Order Qty	1
Weight/Ea.	72 lbs
Weight Per Pallet	1800 lbs

Notes

Square Shaft (150) Lead Section, 84" Length (2134 mm) long with 10" (254 mm)-12" (305 mm) Helices