

TAE-175-80-14-14 -- Square Shaft 1-1/2" RCS Extension with Double 14" Helix

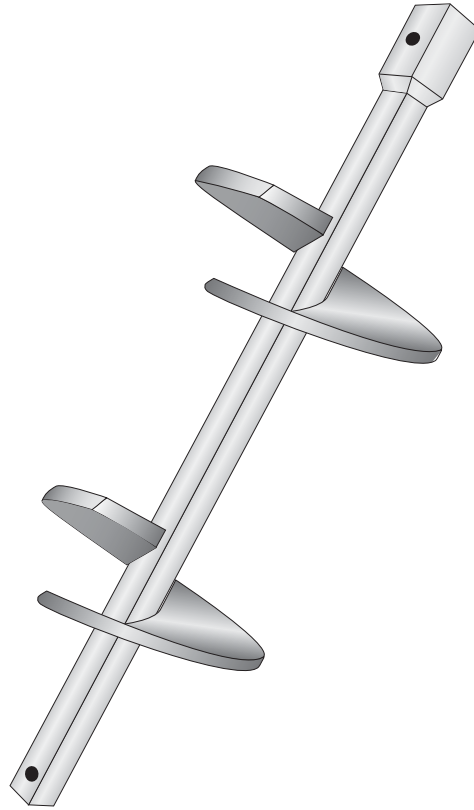

Product Specifications	
Anchor Style	Square Shaft (175) Anchor
Component	Extension with Helix
Length	80" (2032 mm)
Number of Helices	2
Helix Diameter	14" (355mm) - 14" (355mm)
Rod Tensile Strength	100,000 lbs (444.8 kN)
Torque Rating	10,000 Ft Lbs (14,914 N-M)
Coating	Hot-Dip Galvanized
Standard Package	20
Standard Package Unit	EA
Min Order Qty	1
Weight/Ea.	92 lbs
Weight Per Pallet	2375 lbs

Notes
 Square Shaft (175) Extension 80"(2134 mm) long with (2) 14" (355mm) Helix